

NEW ! "Beginner Series"...PO - 002 Crystal Radio Kit, for Advancing Beginners !
No soldering required, featuring that "handmade look" with genuine, pre-drilled wood base and front panel.

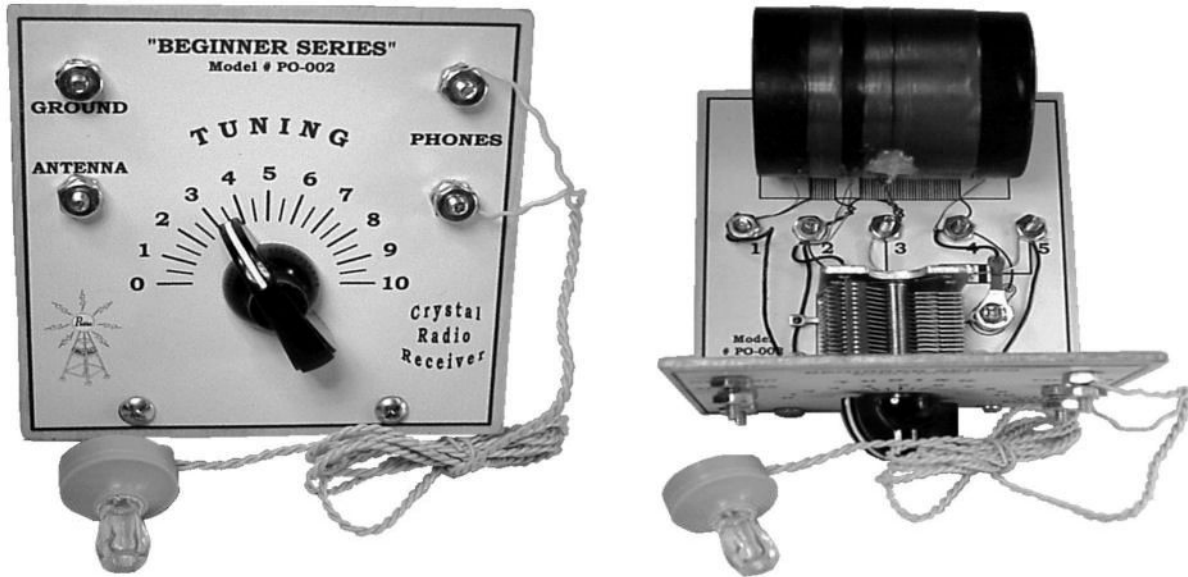

This radio kit, being the next step-up-kit, is perfect for parents, grandparents, and teachers to build with kids! It is also a super starter kit for the beginning adult builder! All parts included are coil form, wire, variable tuning capacitor, other necessary components, and diode. Easy parts layout guide provided for kids. Excellent performance for such a simple but, elegant classic receiver design. A nice addition for the advancing experimenter would be the XS-004 Antenna Coupler, and the book, "Radios That Work for Free". Both found here, amongst our other fine collections.!

Featuring a genuine, high performance, easily wound coil on 2" x 2-12" Mailing Tube form.
PO-002 Crystal Radio Kit, 3-3/4" x 3-3/4" x 3-7/8", w/Earphone shown included, (antenna not included)

What You Will Find Inside:

- Page #1: From transmitting station to receiver, the whole picture.
- Page #2: A little information about the parts you will be using in this project, schematic-symbols diagram, coil details.
- Page #3: Assembly procedure.
- Page #4: Operating & experimenting procedure.
- Page #5: Assembly figures.
- Page #6: Antenna & ground ideas.
- Page #7: Parts list & glue-on templates.

Tools and Supplies You Will Need:

Scissors, Needle-Nose Pliers, Wire Cutter, #2 Philips Screw-Driver, Small, Straight-Blade Screw-Driver, Sharp Knife and/or Wire Stripper, Awl or Ice Pick, Paper Paste, Medium Sand-Paper, Antenna & Ground (See page #6)

Have fun building your kit, and if you need any assistance, email Mike at:

peeblesoriginals@comcast.net

Peebles Originals
All Rights Reserved

From Transmitting Station to Receiver, The Whole Picture:

The transmitting antenna of the radio station, radiates the signal into "air-space", "A". The signal travels at the speed of light, and is immediately absorbed by the receiver's antenna, feeding the signal on-to the receiver. The signal has two components, the music or voice content, "B", which is referred to as modulation. The sound vibrations are converted to electrical, audio sound waves that are picked-up by the microphone, amplified, then feeding the modulation to the transmitter.

The second component is what we refer to as the RF (Radio Frequency) carrier "C". This RF carrier, oscillates at an exact frequency, which is what is commonly called the station's operating frequency, and is produced to exactness at the transmitter. The crystal radios we are presenting here, operate on the AM broadcast band, of which the frequencies are: 540 KHz to 1,700 KHz. kHz is the abbreviation for kilohertz, which is the term for frequency x 1,000 Hz / second. An example would be a station at 750 KHz, would oscillate (change the signal from positive to negative) at a rate of 750,000 times per second, "C".

When the audio content or modulation is added to the radio frequency content, or RF carrier, as in "D" we then have a modulated, AM carrier signal (RF signal). This is the signal that will travel through the air, to the receiver. The RF carrier signal will remain the same, but the height of the signal is changing, in accordance to the intensity of the introduced modulation. This is what is called, amplitude modulation (AM) as shown in "D". This means that the signal height is always changing, but the width or frequency of the signal always remains the same. Radio signals are like a battery, in the sense that they must complete a circuit. A battery will complete a circuit, by the electrons moving from the positive terminal, through the associated circuit, and returning at the negative terminal, etc. Radio signals complete their circuit by their origin being transmitted out of the antenna against Earth ground, and returning to Earth ground, from receiver's antenna/ground. This will be discussed in more detail, later.





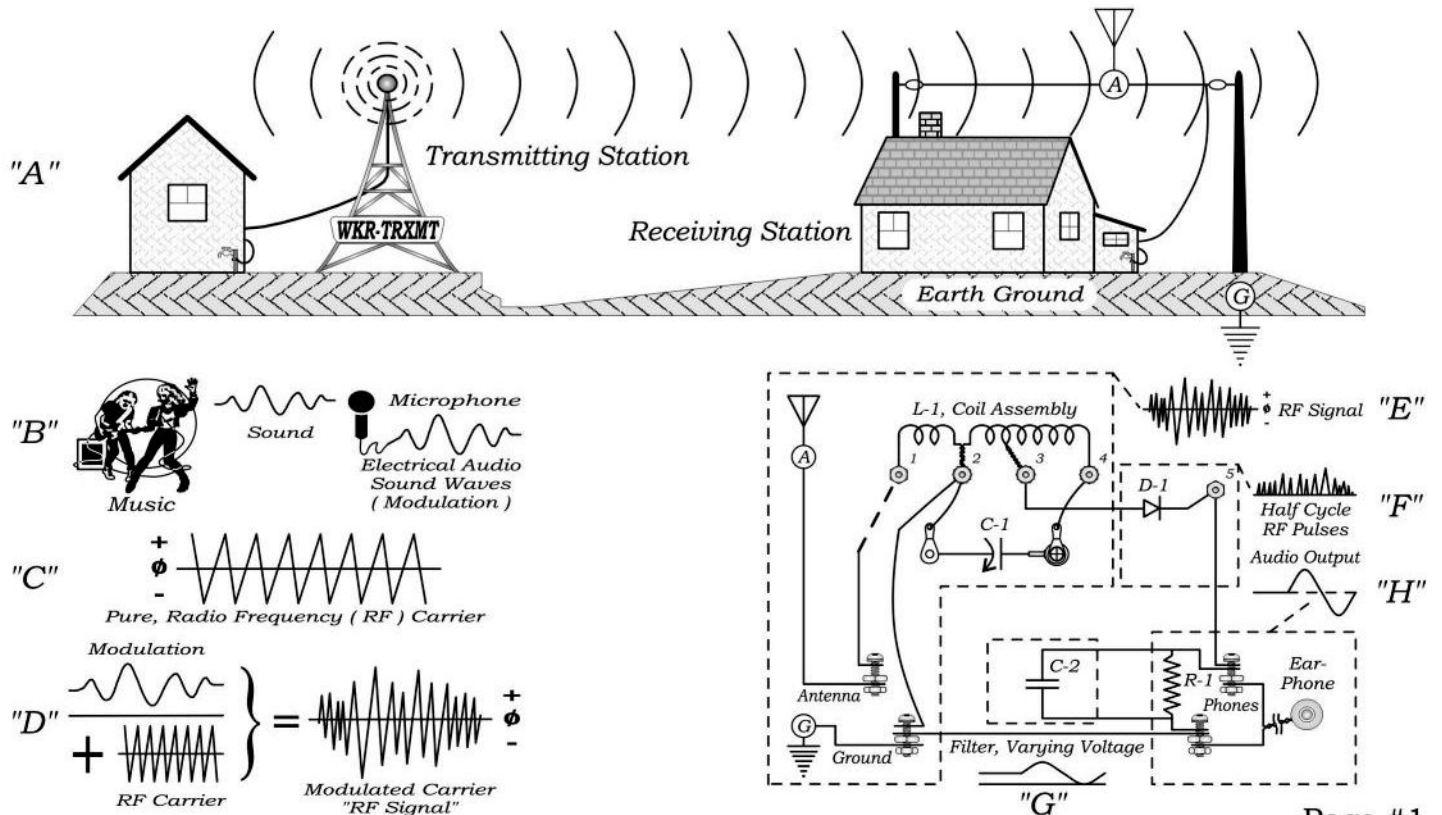





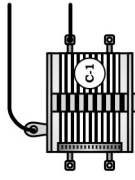
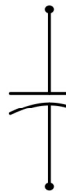
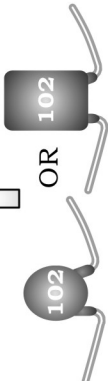
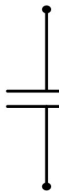

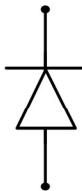
The receiver attracts the radio signal, at antenna/ground. L-1/C-1 tunes the (filters) the RF carrier frequency to

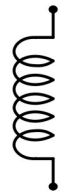
it's exact signal, "E". Now the signal is passed through the diode, D-1 which rectifies the signal, separating most of the modulation content of the signal, from the RF carrier portion of the signal, "F". You will note that the lower or negative side of the signal has been eliminated, leaving a small portion of the RF carrier, and mostly audio content at this point. This is called detection, and the remainder of the small RF carrier content is filtered-out, by capacitor C-1, "G". The audio content is then reproduced at the earphones, "H"

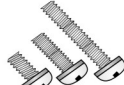

A Little Information on the Parts You Will Be Using For This Project:

Name of Part: _____ Illustration _____ Schematic Symbol _____

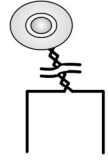
C-1, Variable Capacitor, "365"		
C-2, Fixed Capacitor, .001uf, Marked "102"		
D-1, Diode, Germanium, Glass w/Stripe		
L-1, 2 or 3, Coil, See Text & Parts List	 Molded, or Cylinder, or Spider-Web	
R-1, Resistor, 47K-ohm, Yel, Vio, Or, Gld		
Knob, Black-Pointer		NONE
Machine Screw, 6-32 x 1/4", 3/8", 1/2"L.		NONE
Hex-Nut, 6-32		NONE
Sheet-Metal Screw, #6 x 1/2"L.		NONE
Earphone, Ceramic/Crystal		

Schematic-Symbols,
Beginner Series,
Model #PO-002,
Connections.

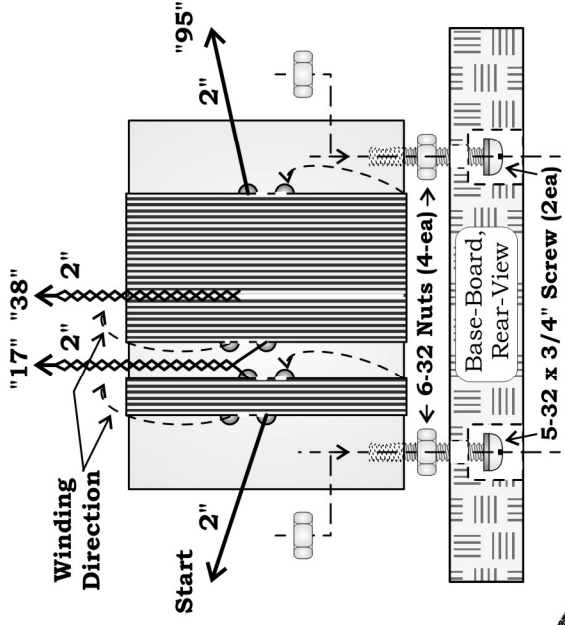
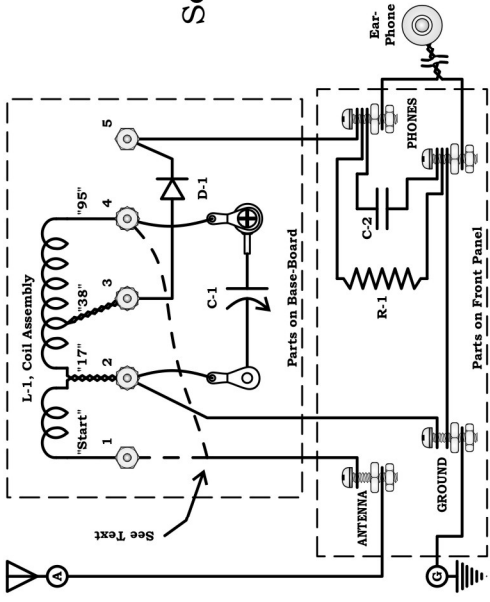

Coil
Details

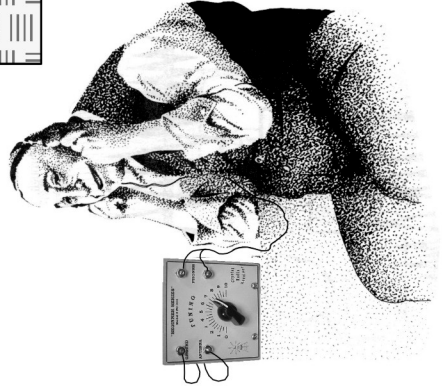

Have FUN!
Just like Grandpa did...

Assembly Procedure:

□ See pages #2, 5 & 7 and familiarize yourself with all the parts involved. Find the *Front-Panel*, the *Base Panel*, and 2ea *Sheet-Metal Screws*. With a pair of scissors, cut-out the 2ea *Templates* on Page #7, as per instructions there. Using a good paper paste, glue these on the outside of the *Front-Panel* and *Base Panel*, making certain they are centered, and facing the proper direction. With a sharp knife, cut-out the large hole in the center of the *Front-Panel*. Using an awl or ice-pick, punch-out all the holes where screws will protrude, or go-through. See Assembly Figure #1: Place the bottom of the *Front-Panel* against the front-edge of the *Base-Panel*, making certain they are square with each-other at the bottom. Mark the 2 mounting holes on the front-edge of the *Base-Panel*, then make "pilot-holes" in the front-edge of the *Base-Panel*, with an awl or ice pick. Attach *Front-Panel* to *Base-Panel* with the 2 *Sheet-Metal Screws*.

□ See Assembly Figure #2 & #3: NOTE: This procedure is very important that it be followed, very carefully. You will need: *Variable Capacitor, w/Wires attached*, and associated hardware. Follow the illustration and carefully assemble the *Variable Capacitor* to the *Front-Panel*, exactly as shown. Do not over-tighten the 2ea *Machine Screws*, through front panel and into variable capacitor, as it may damage the *Variable Capacitor*.

□ See *Coil Details, Page #2*: Locate *Coil Form & Coil Wire*. Find the beginning of the supply of *Coil Wire* and place the coil of wire, around a heavy-round object, so the supply will not kink as you wind the *Coil Assembly*. Place the *Coil-Form* in front of you, so the large holes are down and the small holes are facing you. See the "Start" wire and insert the *Wire* through the upper-small hole and bring it back-through the lower-small hole, leaving 2"L. Proceed to wind the turns, in a "clock-wise" manner, tightly and evenly. When you reach the next set of holes, cut-off the *Wire* supply, leaving 2-1/2"L. Run the wire through the holes as before. At "17", and the next set of holes, proceed by inserting the *Wire* through the holes as before, leaving another 2-1/2"L, and wind another "21" turns until you reach the "38" point. Hold the *Wire* against the form with your thumb and pull-out a 2-1/2" loop, and twist the loop, tightly, at the "38" point, then proceed to wind to "95". Cut-off the wire supply, leaving 2-1/2" to insert through the holes as before. Make certain the *Coil* is tight and even. You may want to put a little spot of "hot glue" at each of the points marked "Start", "17", "38", and "95", to secure the wires. At the "38" point, cut the end of the loop, so there are two wires. With a small piece of medium grit sandpaper, sand the coating off the end of each *Wire*, about 3/4"L. Make certain all the coating is sanded-off and you can plainly see the shininess of the copper, all the way around the *Wire*...This is very important. Tightly twist the two *Wires* together at "17" and "38", we call these "taps". Make certain that there is at least 2" of *Wire* at: "Start", "17", "38" & "95", and this concludes the *Coil Assembly*. Mount it to the *Base-Panel*, as shown with two, 3/4" *Screws* and four *Nuts*, as shown. All *Wires* facing, to the front.

□ See Assembly Figure #3, *Front-Panel, Back-Side View*: You will need: *Hook-Up Wire*, and cut a 3-1/2" piece, a 4" piece, and 2ea-5" pieces. At the end of each *Wire*, strip-off the insulation, about 3/4" long. be careful to not cut or nick the *Wire*. This can be done with a sharp knife or a wire stripper. Locate: 4ea-1/2" *Machine Screws*, 8ea *Hex-Nuts*, *Resistor*, and *Fixed-Capacitor*. Following the illustration very carefully, assemble all the parts to the *Front-Panel*, as shown. All wires that are under the *Screw-Heads* should be made to look like a "fish-hook" and when the *Screw* is tightened-down then make certain each *Wire* is mechanically solid, under the *Screw-Heads*.

□ See Assembly Figure #3, *Base-Board, Top-View*: You will need: 5ea-1/2" *Machine Screws*, and 5ea *Hex-Nuts*. Install the 5ea *Machine Screws*, up-through the holes in the *Base-Board* as shown. You will need a #2 Philips screw driver for this, as the *Screws* will need to be actually turned up-through the holes, until snug. Locate: *Diode*, and 5ea *Hex-Nuts*: Using the above procedure, "fish-hooking" the *Wires*, attach the *Coil's Wires*, *Diode* and 2 *Wires* from the *Variable Capacitor*, and 4" *Wire* from "Phones" & 5" from "Ground" from *Front-Panel* as shown, under the 5ea *Hex-Nuts*. Locate 1ea *Hex-Nut* and attach 5" *Wire* (*Antenna*) from *Front-Panel* to #1 or #4 *Screw* on *Base-Board*, depending on length of *Antenna*. Note: *Longer Antennas*, the 5" *Wire* will want to attach to #1, and very short *Antennas* will want to attach to #4. This is an *Experimental Procedure*, so you will want to refer to the: *Testing, Operating and Experimenting* section that is on the next page. Locate the *Earphone* and attach it's 2 *Wires* to the "Phones" terminals in a like manner with above *Wires*.

This concludes the assembly of your receiver. This is a good time to re-check all your assembly and wiring, making certain all is as shown in illustrations and in the above instructions.

See Page #6 and fully understand the *Antenna and Ground* system involved for your receiver, and the suggested options, that will fit your needs.

Proceed to *Testing, Operating and Experimenting* on the next page...

Testing, Operating & Experimenting Procedure:

- After you have studied and set-up your *Antenna/Ground* system, as per *Page #6*, you are now ready to connect your *Antenna & Ground*. See *Assembly Figure #3*: There is a wire from the *Antenna Terminal*, that indicates to connect to: #1 or #4 *Terminal Screw*, where *L-1, "Start"* terminates. Connect this "*Jumper Wire*" to #4, at this time, and you may change it, later. Connect *Antenna* and *Ground* wires, to the proper *Terminals* on the *Front-Panel*.
- Put the *Earphone* into your ear and slowly rotate the *Tuning Control*, listening for stations. If stations are heard, then proceed. If not then: 1) Check all your wiring, step-by-step, making certain all assembly and connections are correct. Make certain you have a proper *Antenna/Ground*, as per instructions on *Page #6*. To check your *Earphone*, brush the *Antenna Wire* on the lower *Earphone Terminal*, and if a "clicking" is heard, *Earphone* is OK. To check the Diode (D-1), brush the *Antenna Wire* on the #4 *Terminal*, and if "clicking" is heard, then Diode is OK. Make certain that *L-1 Coil's Wires* are in their proper places, as per *Step #4* in *Assembly Procedure*. If all the previous steps have been covered with no problems found or corrected and set still does not work, then please contact us for further instructions: peeblesoriginals@comcast.net
- When set is working, then note if your stations are well-separated and clear, or whether they tend to be all mixed together. If the stations do-not separate well then, try a shorter *Antenna*, or remove the *Ground Wire*. If the stations seem weak and very few, then move the *Antenna Jumper* that is now on *Terminal #4*, to #1. When you have determined the proper settings, getting the best reception, then your set is working to it's *maximum capacity*, for your *location* and *Antenna/Ground* situation. Don't expect "ear-busting" volume and/or all the stations that your table-model radio can produce. After-all, you are working with a receiver that is like the very first radio, in radio's evolution. Our technology has highly increased in the past 100 years, and you are dealing with it's earliest "roots". Hope you had fun with assembling your set, and next are some suggestions for experimenting, to draw some conclusions of interest, or for your *Science Fair*.

Some Basic Experiments to Perform:

- 1) Denote how many stations you can receive in the day-time, and then at night-time. You should receive more at night and there should be an increase in volume with some. Stations usually decrease power at night and sometimes change *Antenna-Signal* direction, as radio transmissions are much-more penetrating in the night-time atmosphere, as opposed to the day-time.
- 2) Denote what happens when you remove the *Ground Wire*.
- 3) Denote what happens when you decrease the size or height of your *Antenna*, or increase it's size or height.
- 4) Denote what happens when you move the "*Antenna Jumper*" wire to *Terminals #1* or #4. t

We have an *Antenna-Coupler Kit*, #PO-004, that is very good for furthering your experiments and will make the set more *Selective & Sensitive*. This is a consideration for further experimenting, and expanded enjoyment of *Crystal Radio Experimenting*. Also, a fine companion to these sets is a book we carry called, "*Radios That Work For Free*".

Hope you have had fun with your set and will consider more projects, furthering the fine world-wide, shared hobby of *Radio Building*.

"A, B, & C": 9ea, 6-32 x 1/2" Machine Screws & 6-32 Hex-Nuts

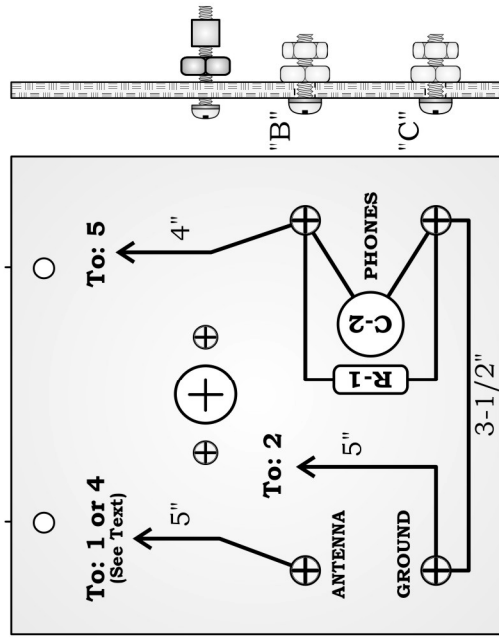
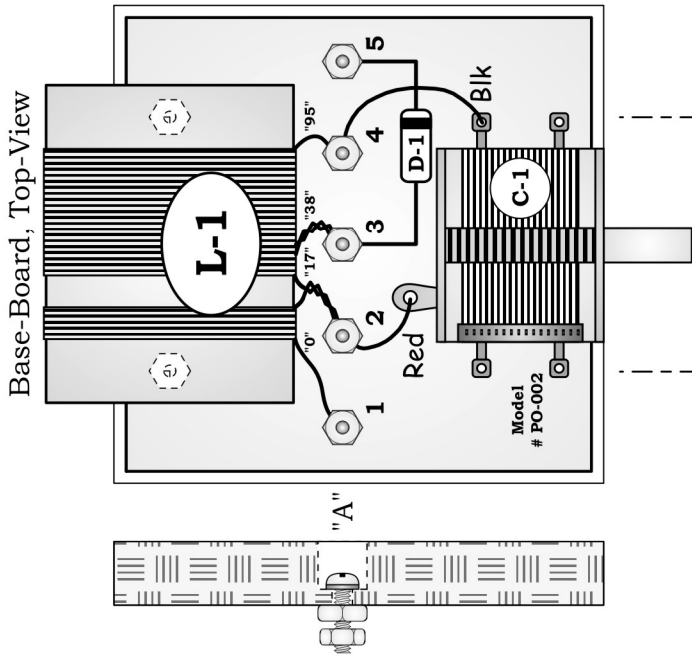

Front-Panel, Back-side View

ASSEMBLY FIGURE #3,
PARTS PLACEMENT & WIRING.

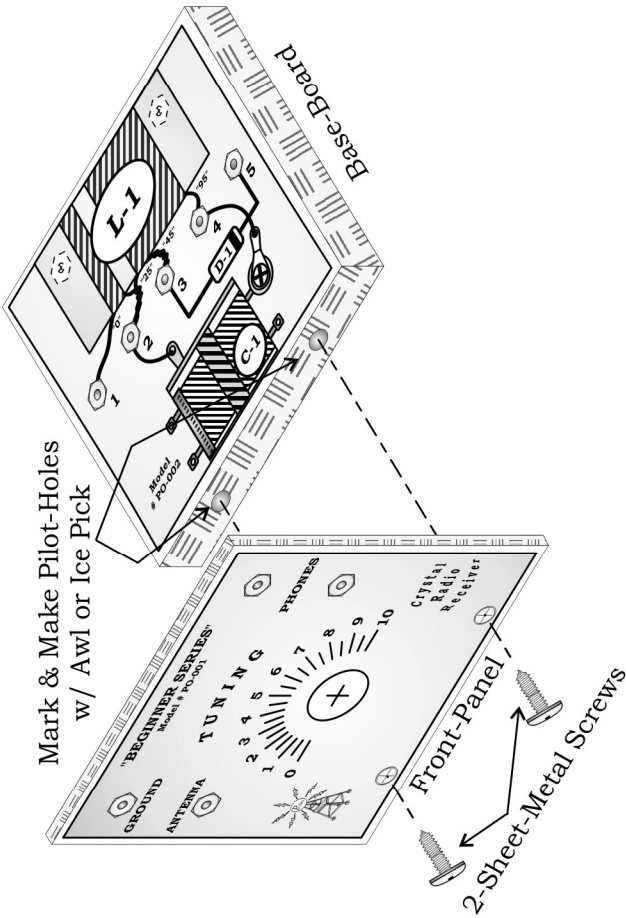

ASSEMBLY FIGURE #1,
ATTACHING FRONT-PANEL, TO BASE-BOARD

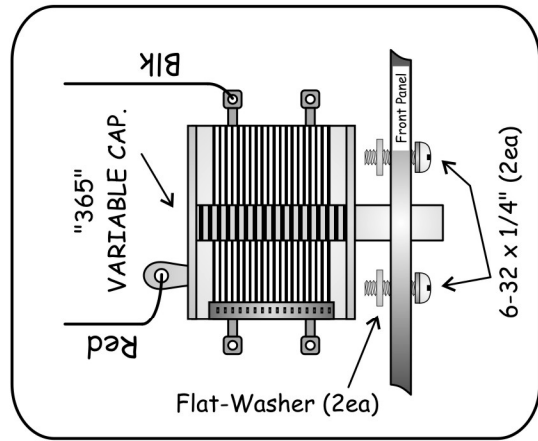

ASSEMBLY FIGURE #2, ATTACHING C-1,
VARIABLE CAPACITOR TO FRONT-PANEL.

Antenna and Ground Ideas

A substantial antenna and ground are an absolute must, for the ultimate pleasure of crystal radio experimentation. See the diagrams below, for the following explanations:

- 1) Antenna Wire, 50-100'; 14 gauge/stranded wire is the most practical here. The wire can be insulated or un-insulated and if 14ga. isn't handy or practical, then use what you have that would be a close substitute.
- 2) Insulators; Any style that is fit for an antenna application may be used here. Make certain that the antenna wire and 6"-8" pieces that tie to the Supports are mechanically sound. These connections should be tightly wrapped around each-other and securely soldered.
- 3) Lead-In Wire; This should be of the insulated variety, or could be 52-72ohm coaxial cable. Make certain the shielding is securely grounded. See #7 on grounding. If a single wire is used, then it should be of as heavy gauge as possible and very well insulated. See #5 on insulators.
- 4) Supports; I have used 15' antenna mast as shown, for my antenna. The supports could be a tree, another building or any object that is as high as possible. Your supports should be as high as absolutely possible, if you live in a "fringe area". Height is not as important in areas that have a large amount of powerful stations nearby. A very important factor here is to keep your antenna and lead-ins clear of utility lines of all types.
- 5) Insulators; Your lead-in wire should be insulated from all objects. Even-though the lead-in itself is insulated, then wire should still be run-through insulators. Radio frequencies have a habit of finding a path to ground easily. When working with very weak signals as we do, in radio experimentation we need all the signal we can obtain to the set.
- 6) Feed-Through Insulators; Should be used to run the wires through the wall, into radio room.
- 7) Ground; This should be a solid path to "earth". This can be accomplished via water-pipes or other direct paths to "earth" ground. Do-not use Gas pipes, here. Make certain your home has metal pipes, or you could get a ground rod from an electrical supply house. They can instruct you for best installation.
- 8) Lightning Arrester: This is a very sensible safety precaution and should be used.

Note:

If it is not possible to run an antenna outside, then there are a few alternatives that can be tried:

- A) The antenna wire could be installed in the attic of your house, in a similar manner as shown below.
- B) A vertical antenna can be made, by using 1-1/2" PVC pipe, and winding wire around it in a spiral fashion for whatever length of pipe you have room for. Run a lead-in to your receiver, from the bottom-end.
- C) A wire can be run around a room near the ceiling and then run the lead-in to your receiver. Use as much wire as you have room for.
- D) Aluminum-framed windows and other, similar metal objects may be tried.

The fun of crystal radio experimenting is to try different things and never be afraid to experiment, safely.

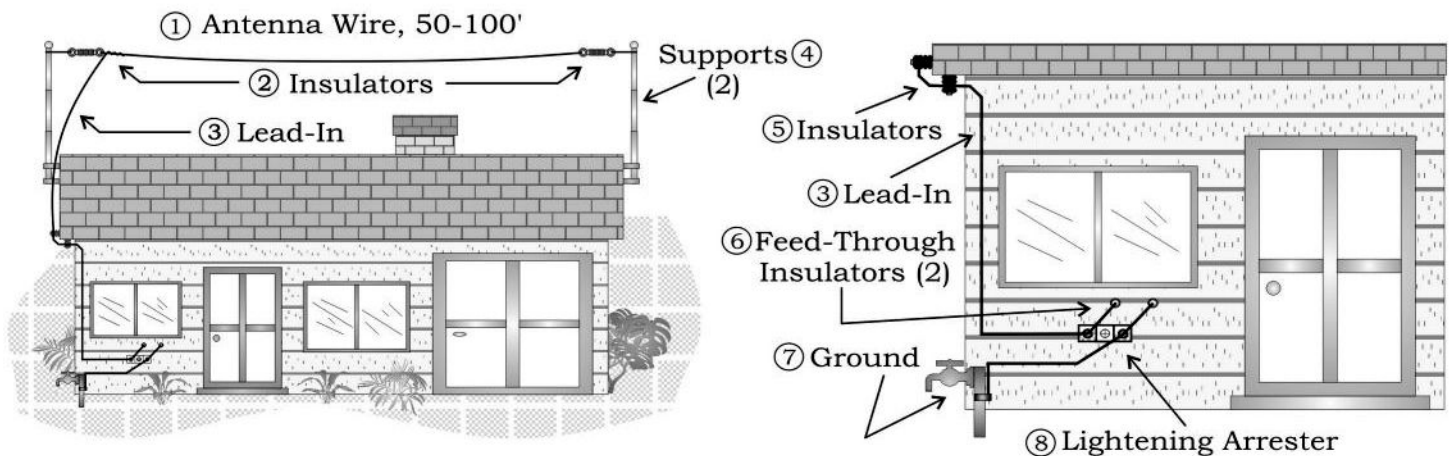

Parts List, Beginner Series, Model #PO-002, Crystal Radio Receiver:

QTY	PART	DESCRIPTION	QTY	PART	DESCRIPTION
1	C-1	Variable Capacitor, 365pf w/Wire & HDW	9	HDW	Machine Screw, 6-32 x 1/2" L.
1	C-2	Fixed Capacitor, 0.001uf, Marked "102"	18	HDW	Hex-Nut, 6-32
1	D-1	Diode, Germanium, Glass w/stripes	2	HDW	Sheet-Metal Screw, #6 x 1/2"
60'	L-1	Coil, Magnet Wire, 28ga.	2'	HDW	Hook-up Wire, Insulated
1	L-1	Coil, Form, 1-5/8"Dia x 2-1/2"L	1	EP	Earphone, Ceramic/Crystal
2	HDW	Machine Screw, 6-32 x 3/4"L.	1	PNL	Front-Panel, 3-3/4" x 3-3/4" x 1/8"
1	R-1	Resistor, 47K-ohm, Stripes: Yel, Vio, Or, Gld	1	CHS	Base-Panel, 3-3/4" x 3-3/4" x 1/2"
1	HDW	Knob, Black-Pointer	1	INST	Manual, Instruction & Assembly

INST=Instruction, HDW=Hardware, EP=Earphones, PNL=Panel, CHS=Chassis

FULL-SIZE TEMPLATES:

Cut-out on outside of heavy lines, and glue to Front Panel and Chassis, with paper glue.



Front-Panel, Dial Plate

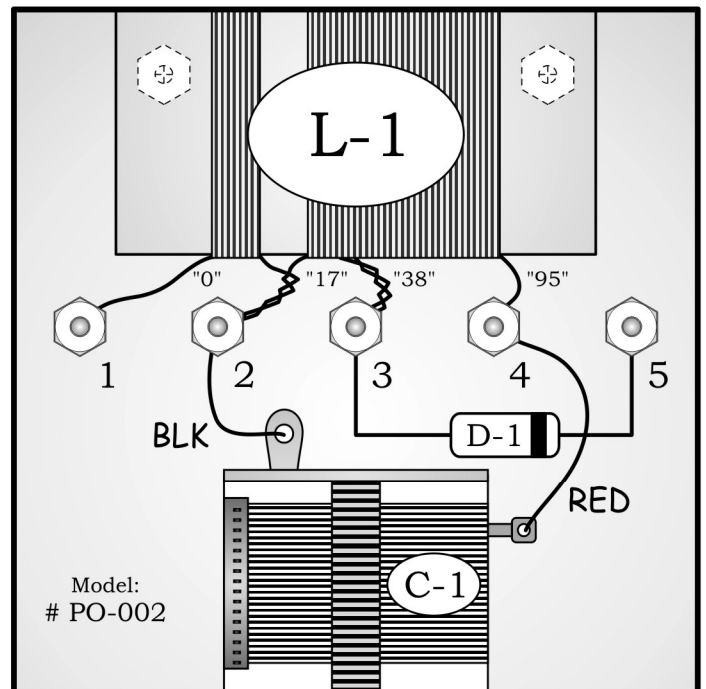

Chassis, Assembly Template